



Life Sciences



Pall MEMBRApplan DG and DGM

Filter Press Technology for Safer Production and Enhanced Productivity

Filtration. Separation. Solution.SM

High Performance Solution for Pharmaceutical and Biotechnological Production

The advantages of fully enclosed filter presses are closely linked to highly reduced operator exposure and increased product yields. For many high cost products like serum based products, it is of enormous interest not to loose any product in order to maximize the process economy. This enclosed system also enables CIP and SIP, as required by GMP for the pharmaceutical industry. The MEMBRAPlan system sets new standards here meeting the requirements of advanced pharmaceutical and biotechnological processes of today and in future.



Fig. 1:
MEMBRAPlan DGM

Application

The MEMBRAplan development was triggered by the demand for a new type of filter for the treatment of pharmaceutical and biological products to obtain high yields of active ingredients. The MEMBRAplan is a system for quantitative solid/liquid separation and recovery as well as for clarifying filtration.

Pall MEMBRAplan range of applications:

- Blood plasma fractionation
- Biomass separation
- Removal of filter aids
- Removal of extraction residues
- Removal of catalysts
- Clarifying filtration



Fig. 2:
MEMBRAplan DG 400 P30

Product Concept

MEMBRApplan systems are used for quantitative solid/liquid separation and recovery as well as for clarifying filtration. For recovery applications, the MEMBRApplan system is supplied with a membrane plate. This new membrane plate technology (**MEMBRApplan DGM**) enables harvesting of valuable active ingredients by pressing out process fluid after filtration.

The solids are compressed with the help of this membrane and the remaining liquid in the filter cake is removed. This results in a dry and compact filter cake, which can easily be removed from the frame. Compared to centrifuges or conventional sheet filters, this technology yields up to 50 % higher outputs. Mechanical compression is very gentle to the product, so that valuable substances e. g. therapeutic proteins that remain in the filter cake for subsequent filtration do not lose their biological activity. Such a loss is often observed when conventional dehydration methods e. g. with pressurized air are applied. In addition, this mechanical compression considerably shortens the process time e. g. compared to centrifugation methods, therefore resulting in an overall process productivity increase.



Fig. 3:
MEMBRApplan DGM 800 K150



Fig. 4:
Membrane plate

Product Concept

The Pall MEMBRAplan is a fully enclosed filter system to fulfill the requirements of highly sophisticated filtration tasks. The product channels are sealed by the depth filter sheets themselves. Therefore, only the filter press, the plates and frames and the depth filter sheets are in contact with the product. An additional O-ring assures that the entire system is hermetically sealed from the surrounding environment.

The MEMBRAplan system is available in the following configurations:

- **DG-K version = plates and frames made of polypropylene**
- **DGM-K version = plates and frames made of polypropylene with membrane plates**
- **DG-P version = plates and frames made of stainless steel**
- **DGM-P version = plates and frames made of stainless steel with membrane plates**

Application examples

- **DG-K version**
Is for clarifying filtration and the system can be cleaned in place (CIP).
- **DGM-K version**
Is for product recovery and the system can be cleaned in place (CIP).
- **DG-P version**
Is for clarifying filtration and the system can be cleaned and steam sterilized in place (CIP plus SIP).
- **DGM-P version**
Is for product recovery and the system can be cleaned in place and steam sterilized in place (CIP plus SIP).



Fig. 5:
MEMBRAplan Polypropylene filter plate

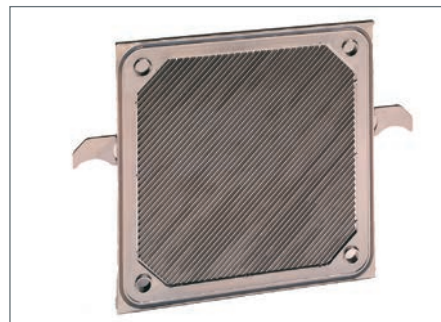

Fig. 6:
MEMBRAplan stainless steel filter plate

Product Concept

The fully enclosed filter press is a big step forward in depth filtration but also the design of the plates and frame is of enormous importance. The design of drainage area of a filter plates is optimized for product flow as well as for high product yields, the design of the frames further enhances product yields.

Features and Benefits

Plate design:

- Enhanced draining plate improves access to outlet holes
- Better and easier cleanability
- Plates are completely drainable, thus no hold-up volume
- Plates are designed under hygienic aspects
- Excellent surface quality

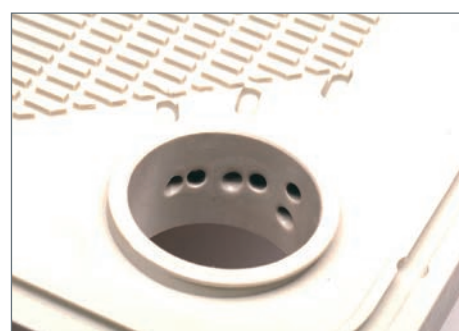

Fig. 7:
MEMBRAplan polypropylene plate

Frame design:

- Full capacity of the filter sheet area, no loss of filter area due to crosses in frame
- Hygienic open design
- Enhanced product yields

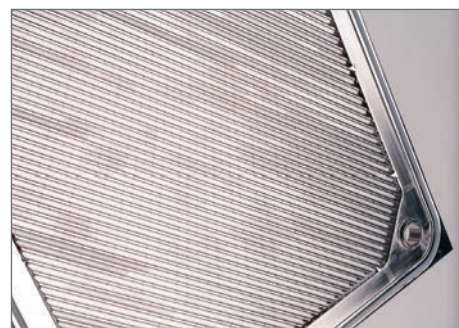

Fig. 8:
MEMBRAplan stainless steel filter plate

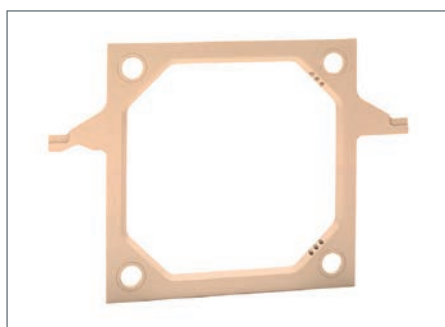

Fig. 9:
MEMBRAplan polypropylene frame

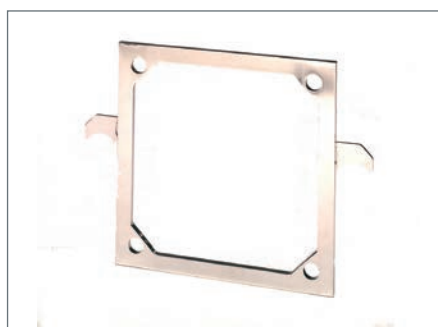
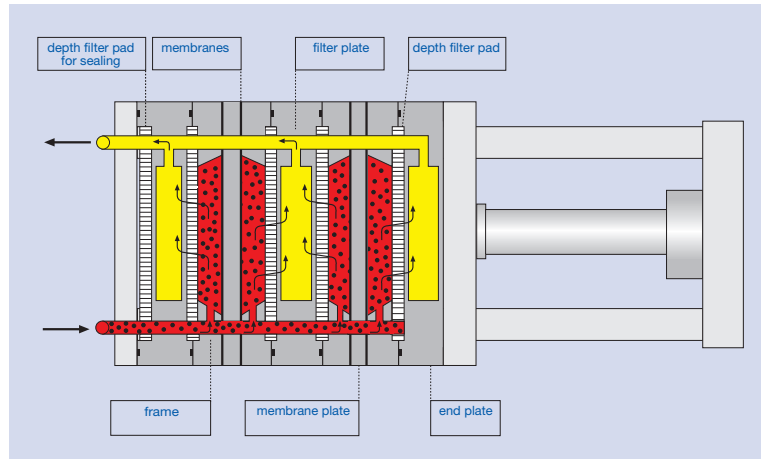

Fig. 10:
MEMBRAplan stainless steel frame

Product Concept

MEMBRAp^{lan}® DGM system with membrane plates during filtration



MEMBRAp^{lan}® DGM system with membrane plates during dehydration of solids

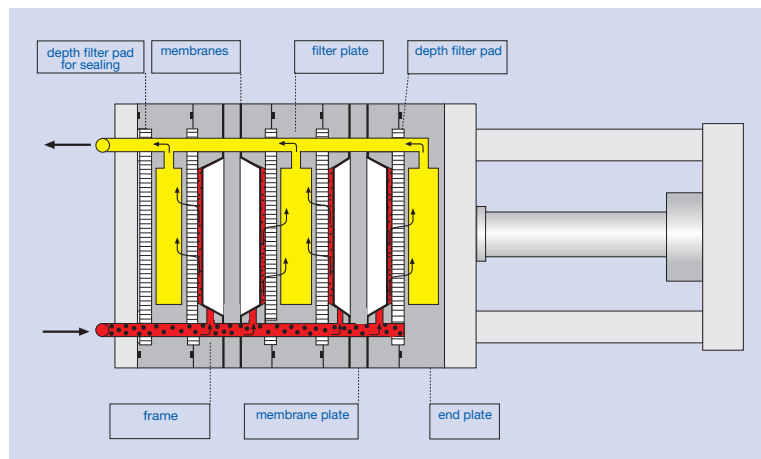

MEMBRAp^{lan}® DG system without membrane plates for clarifying filtration

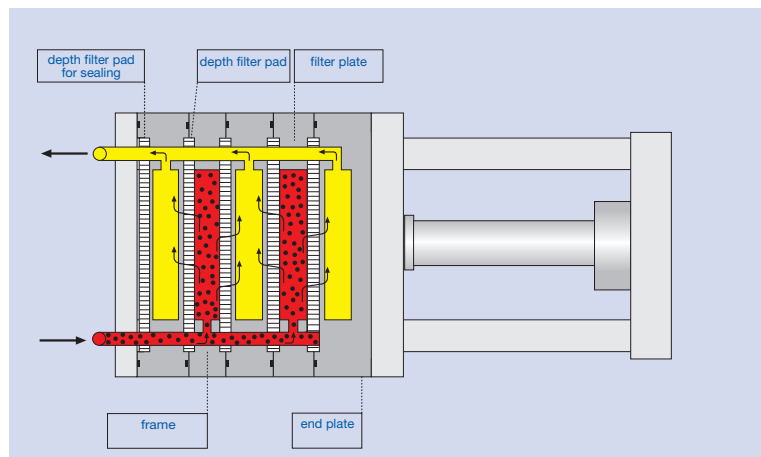

Pall MEMBRApplan technology

The fully enclosed filter press

Product Concept

Due to the enclosed design of the MEMBRApplan a complete CIP cleaning can be carried out, which – in combination with manual precleaning – achieves the reproducibility of the cleaning method required by the FDA Inspection on Cleaning Validation. The filter plate was especially developed for the strict requirements of hygiene and cleanliness in the biotechnological and pharmaceutical industry, on the basis of the recommendations and regulations of FDA, GMP, 3-A, BN and ISPE.

Automation

To minimize operational costs, the MEMBRApplan® filters can be automated for the use in the pharmaceutical industry following the GAMP Guidance. Automation is recommended for filters with a filter area of at least 40 m² or for filters sized 80 x 80 cm or larger. For this purpose, systems in pharmaceutical design are available as well as cleaning portals with automatic plate transportation for automatic plate cleaning.

After removal of the solids and the depth filter media, the plate transportation system and the cleaning portal ensure automatic cleaning of the filter presses. As soon as the cleaning program (including an in-line CIP step) is finished, the filter can be loaded with new depth filter sheets. Cleaning speed and number of cleaning cycles are adjustable.

The construction of these systems combine high safety with low maintenance.



Fig. 11 and 12:
Automated MEMBRApplan DG 1000-K system

Benefits for the customer

- **Productivity**

In the DGM system mechanical dehydration is carried out in only a few minutes by pressuring the membrane plates, delivering a dry and compact filter cake. This procedure shortens the drying period considerably and the reduced overall process time makes it possible to also handle temperature sensitive products. Additional cooling is no longer necessary.

In the DG system (most for clarifying filtration) low volume hold-ups and optimal fluid handling mean minimum loss and maximum yield are achieved.

- **Safety**

The filter is hermetically sealed from the surrounding air. Thus, drip losses during filtration are eliminated. Especially developed filter sheets can achieve quantitative separation of the fractions. The MEMBRAplan filters can be used in explosion hazard areas because the closing of the filter pack is carried out via a pneumatically operated hydraulic system. The hydraulic cylinder is additionally supplied with a mechanical locking device in order to keep the filter press closed even in the loss of power.

- **Handling**

The optional use of polypropylene essentially reduces the weight of the plates and frames, thus enabling simple handling and labour reduction.

- **CIP and SIP**

The enclosed MEMBRAplan filter can be cleaned and steamed in place. The filter plates are constructed to minimize hold-up spaces. An automatic cleaning process reduces the risk of cross contamination.

- **Upscale**

The MEMBRAplan filter is available in all conventional sizes (40 x 40, 50 x 50, 60 x 60, 80 x 80) cm. Sizes 30 x 30 cm and 100 x 100 cm are available upon request.

- **Service**

Besides filter equipment and media Pall also offers a vast variety of services. Our experts have profound knowledge of all kinds of processes and would be pleased to advise you in system planning and filtration optimisation.

Technical Documentation

The MEMBRAplan DGM filter presses are delivered with a complete documentation package. This documentation package consists of

■ Design Qualification (DQ)

■ Project Quality Plan

- Including Project Quality Manual

■ FAT

- FAT 1
 - Inspection of Surface Roughness
 - Measurement of the Ferrite Content
 - Welding Documentation
 - Material Certificates (3.1B; FDA Listing Information) for parts in contact with the product
- FAT 2
 - Pressure Hold Test
- FAT 3
 - Review of the Technical Documentation

■ Technical Documentation

- CE conformity declaration
- Operation Instruction
- Hazard Analysis
- Construction Drawings
- Handling and Maintenance Instruction for Accessories

■ Certificate According DIN EN ISO 9001:2000

Dimensions (in mm) MEMBRAp_{lan} DG and DGM

MEMBRAp _{lan} DG / DGM	L ₁	L _{2min}	L _{2max}	L ₃	B ₁	B ₂	H ₁
DG/DGM 400 K 30 / DG/DGM 500 P 30	1200/920	520/220	920/620	1920/1610	470/570	550/650	1000/1157
DG/DGM 400 K 60 / DG/DGM 500 P 60	1950/1420	1150/620	1650/1120	2750/2210	470/570	550/650	1000/1157
DG/DGM 400 K 100 / DG/DGM 500 P 100	2870/2020	1970/1120	2570/1720	3760/2910	470/570	550/650	1000/1157
DG/DGM 600 K 50 / DG/DGM 600 P 50	1900/1370	940/530	1440/930	2660/1990	720/720	940/940	1090/1090
DG/DGM 600 K 100 / DG/DGM 600 P 100	3100/2160	1860/1220	2660/1720	4160/2820	720/720	940/940	1090/1090
DG/DGM 600 K 150 / DG/DGM 600 P 150	4250/2900	2810/1670	3810/3470	5510/3970	720/720	940/940	1090/1090
DG/DGM 600 K 200 / DG/DGM 600 P 200	5450/3660	4010/2220	5010/3220	6760/4920	720/720	940/940	1090/1090
DG/DGM 800 K 50 / DG/DGM 800 P 50	2040/1530	940/520	1440/920	2775/2270	950/950	1150/1150	1400/1400
DG/DGM 800 K 100 / DG/DGM 800 P 100	3270/2330	1970/1120	2670/1720	4155/3580	950/950	1150/1150	1400/1400
DG/DGM 800 K 150 / DG/DGM 800 P 150	4420/3080	2820/1670	3820/2470	5600/4430	950/950	1150/1150	1400/1400
DG/DGM 800 K 200 / DG/DGM 800 P 200	5620/3880	4020/2270	5020/3270	6800/5430	950/950	1150/1150	1400/1400

Black = with Polypropylene plates and frames (25.4 mm = 1 in)

Blue = with Stainless steel plates and frames (25.4 mm = 1 in)

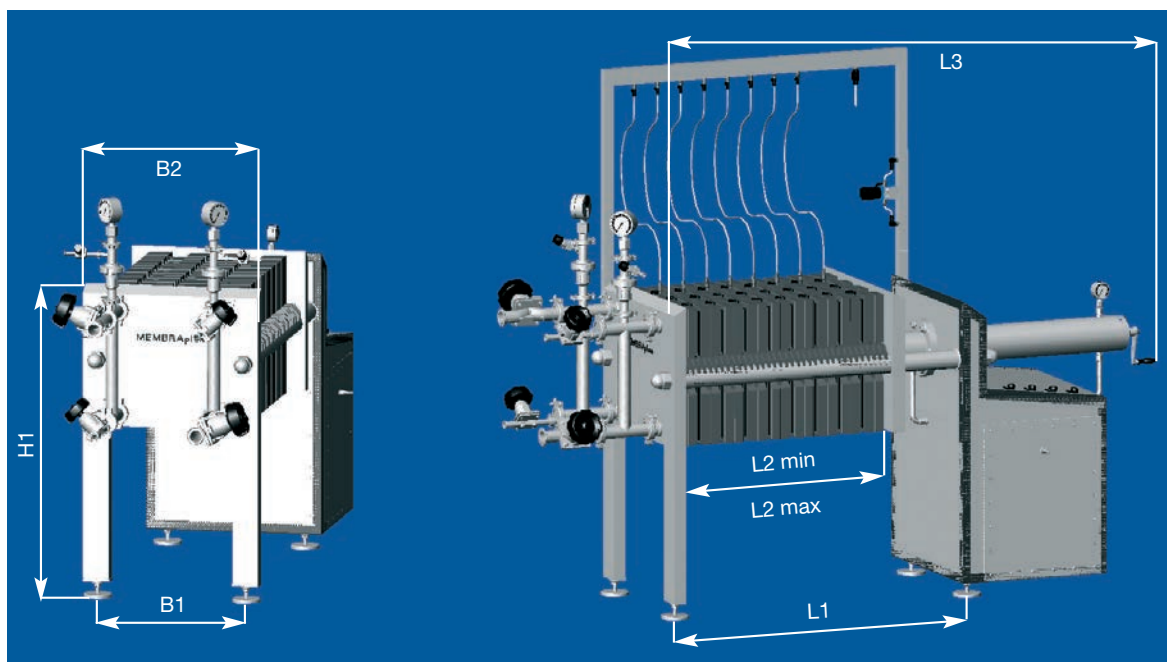

Materials

Materials	
Chassis, parts in contact with product	AISI 316 L
Filter pack	Polypropylene or Stainless steel
Membrane	Santoprene
Gaskets (O-ring)	Silicone / EPDM / Viton™



Life Sciences

New York - USA

+1 516 484 5400 phone
+1 516 801 9548 fax
pharmafilter@pall.com e-mail

Portsmouth - Europe

+44 (0)23 9230 3303 phone
+44 (0)23 9230 2506 fax
BioPharmUK@europe@pall.com e-mail

Filtration. Separation. Solution.sm

Visit us on the web at www.pall.com

Pall Corporation has offices and plants throughout the world in locations including: Argentina, Australia, Austria, Belgium, Brazil, Canada, China, France, Germany, India, Indonesia, Ireland, Italy, Japan, Korea, Malaysia, Mexico, the Netherlands, New Zealand, Norway, Poland, Puerto Rico, Russia, Singapore, South Africa, Spain, Sweden, Switzerland, Taiwan, Thailand, United Kingdom, United States, and Venezuela. Distributors are located in all major industrial areas of the world.

Because of developments in technology these data or procedures may be subject to change. Consequently we advise users to review their continuing validity annually. PALL, Pall and MEMBRAPlan are trademarks of Pall Corporation. Filtration, Separation, Solution, is a service mark of Pall Corporation.

Part Numbers quoted above are protected by the Copyright of Pall Europe Limited. Viton is a trademark of Dupont.

© Indicates a Pall trademark registered in the USA.
© Copyright 2004. Pall Europe Limited.